

# Introduction to Wireless Sensor Actuator Networks

Pritee Parwekar

# Terminology

---

- **Mote :**

**A sensor node also known as a mote  
(North America)**

**Processing+gathering sensory  
info+communicating**

# Terminology (Cont)

---

- **TinyOS:**
- **An open source, Berkley Software Distribution**
  - licensed operating system designed for low-power wireless devices, those used in sensor networks, ubiquitous computing, personal area networks, smart buildings.

# Terminology (Cont)

---

- **GCC**: GNU compiler collection, a compiler system produced by the GNU Project supporting various programming languages.
- GNU is a UNIX-compatible operating system

# Terminology (Cont)

---

- **Basestation:**
- The head of a wireless sensor network. This is the Mote that sends the data back to a computer for analysis. Moteview compiles the data from the network into an SQL database.

# Basestation

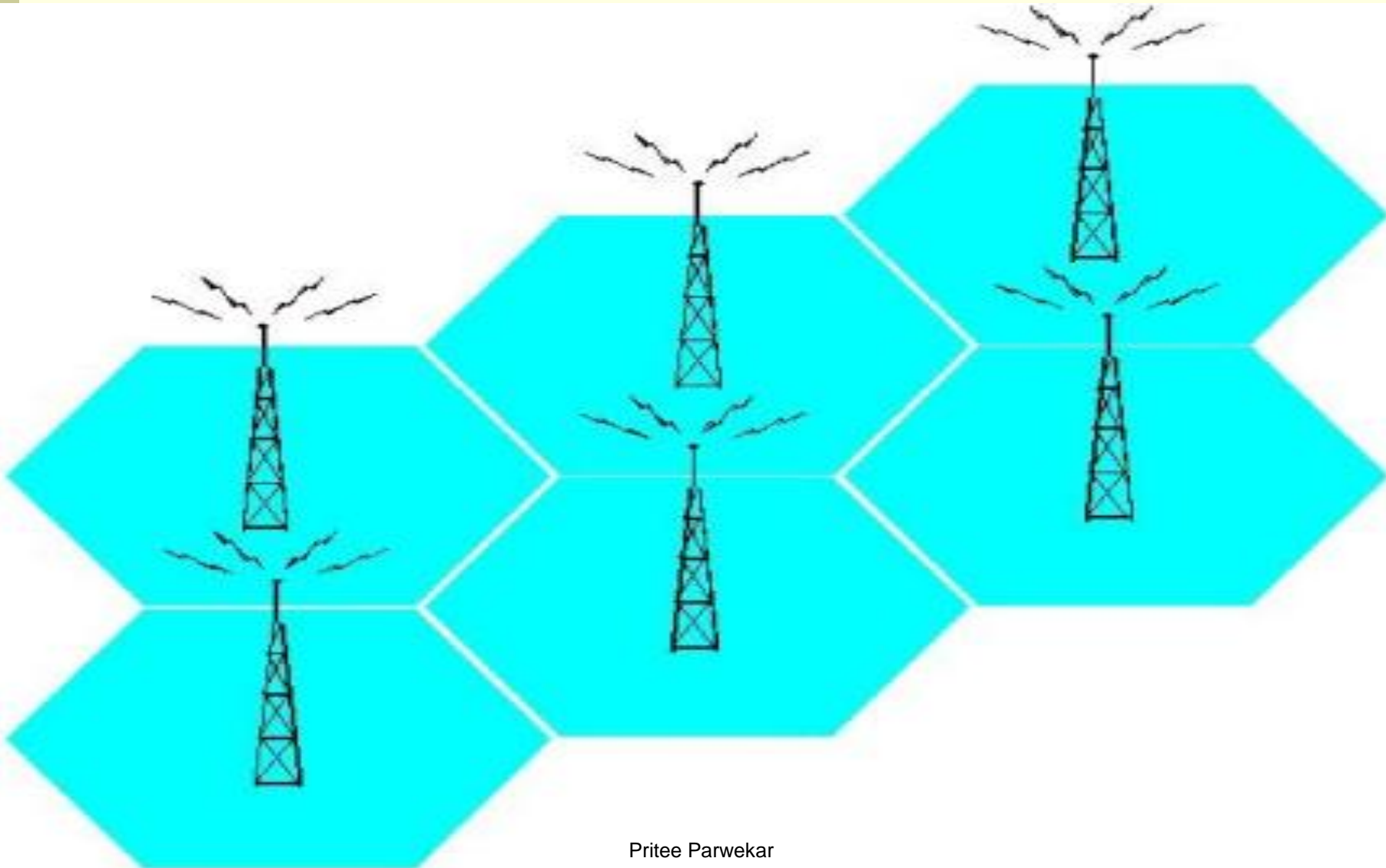

# Basestation

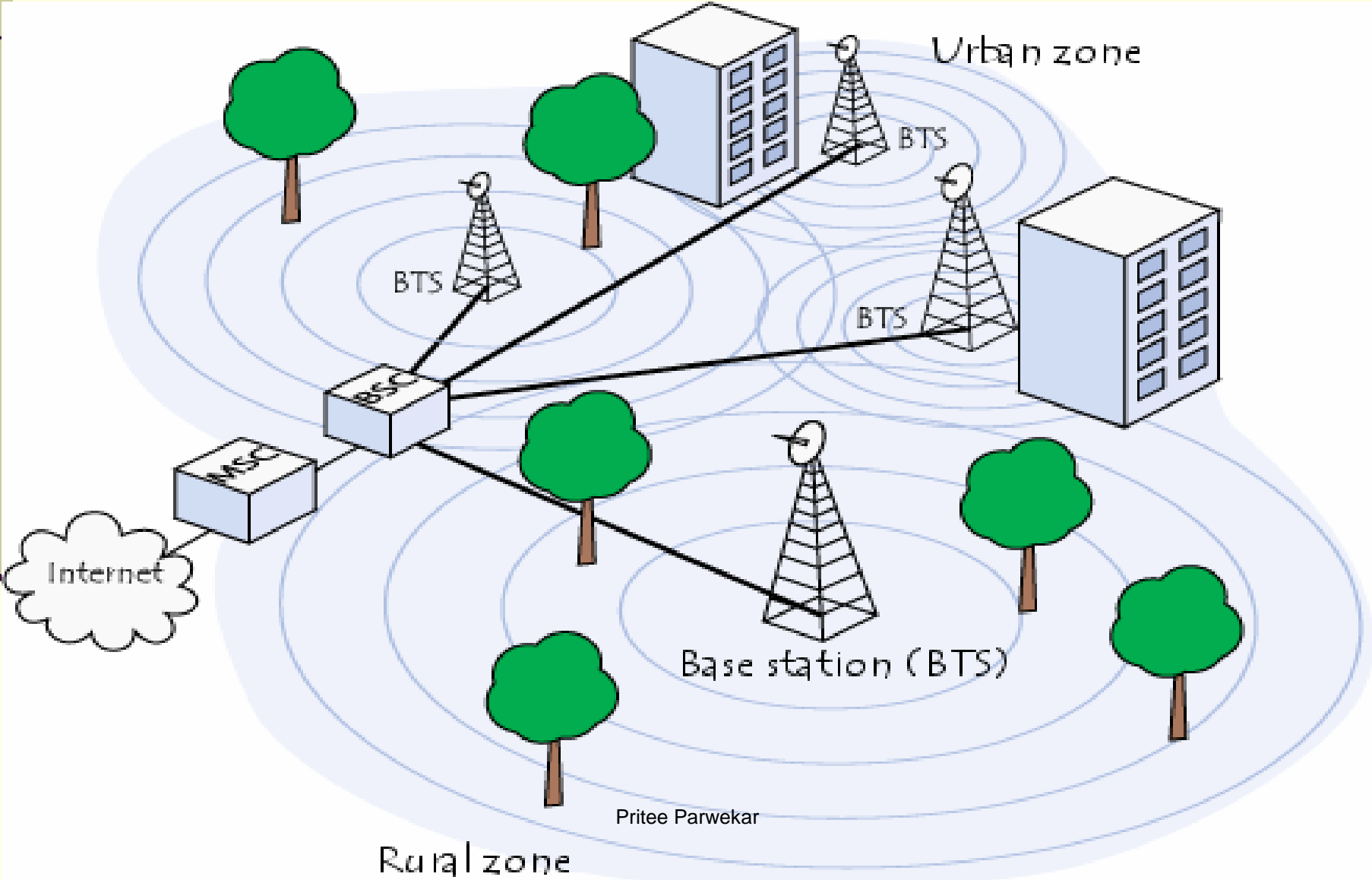

# Mobile Basestation

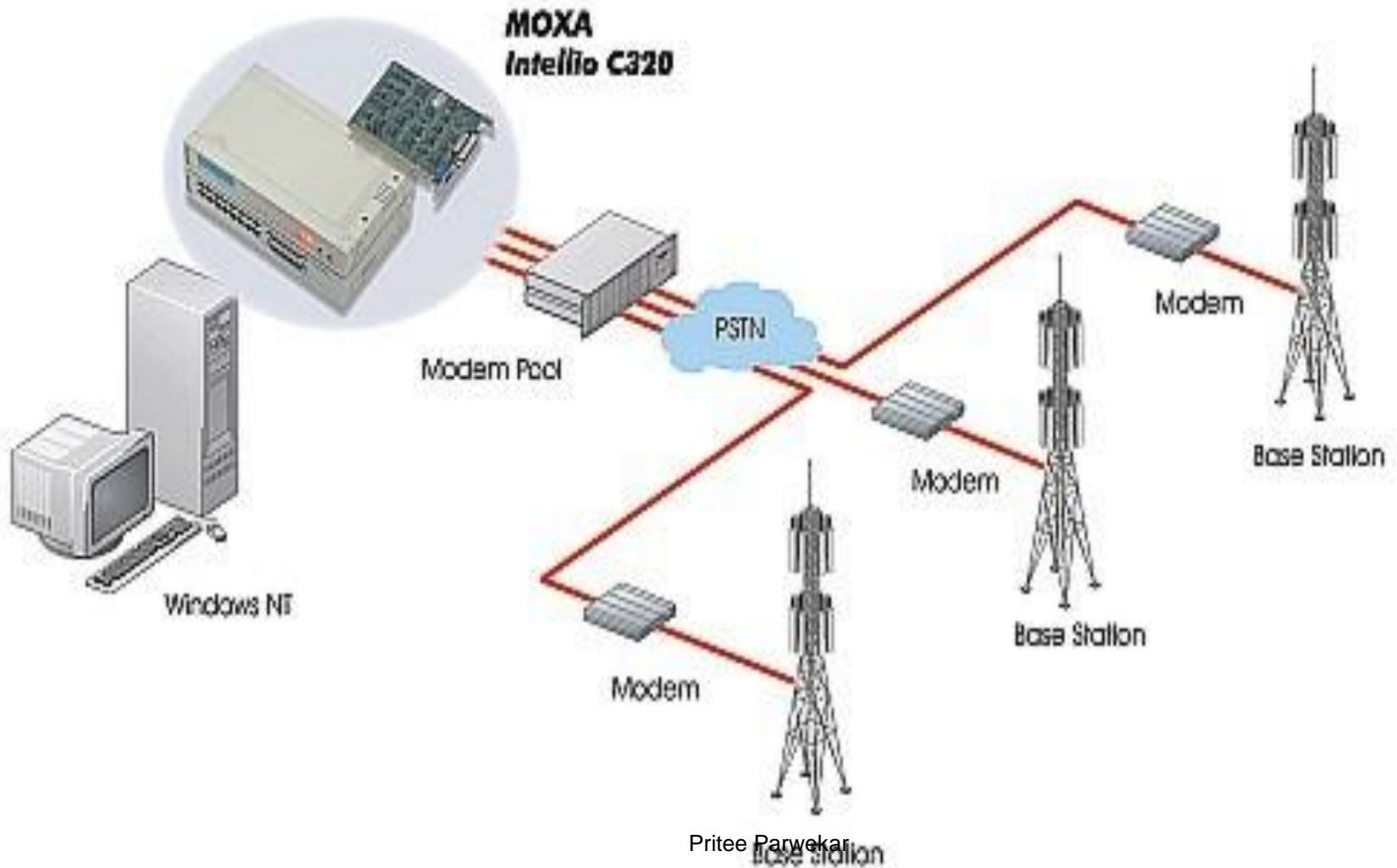



# Terminology (Cont)

---

- Gateway:
- An intermediate node that performs data aggregation from the sensor nodes. It 'sniffs' for packets from the radio transmissions of the sensor nodes.

# Gateway

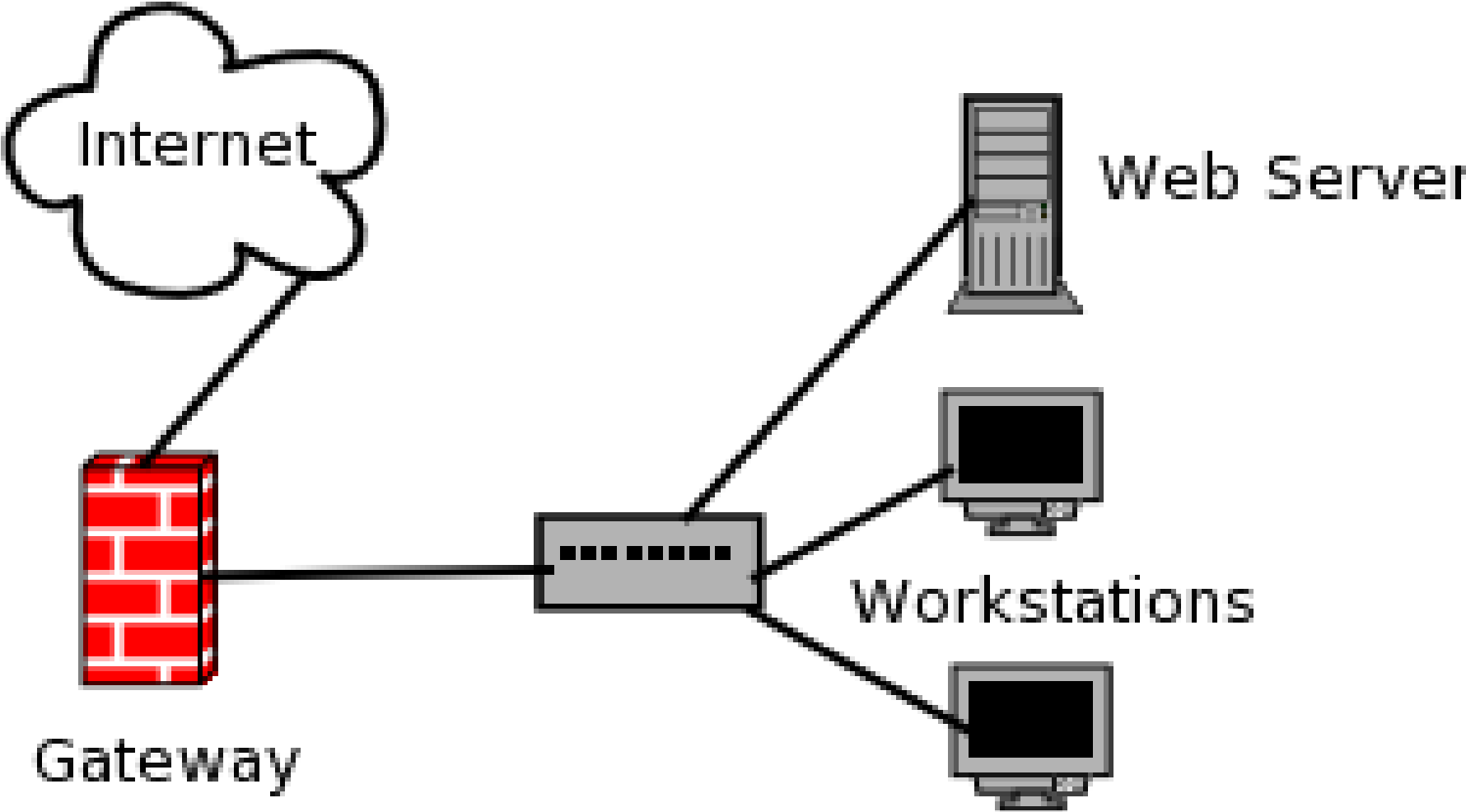

# Gateway-sms

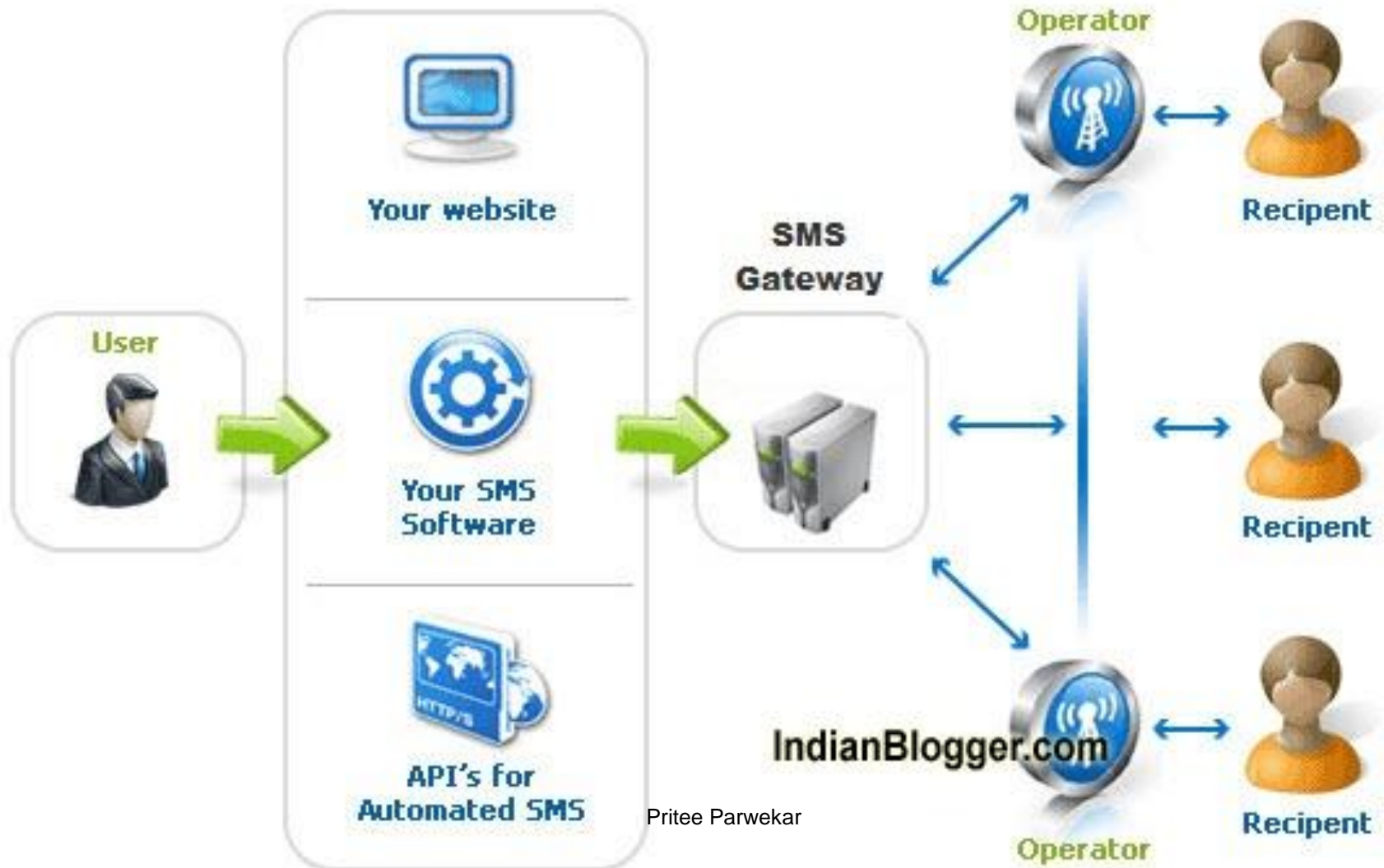

# Terminology (Cont)

---

- Node: Most general term for a device in the wireless sensor network.
  - This nomenclature is also used when assigning the number to a device during compilation.
  - *The base station must be compiled using node 0.*

# Common Sensor Types



Tension

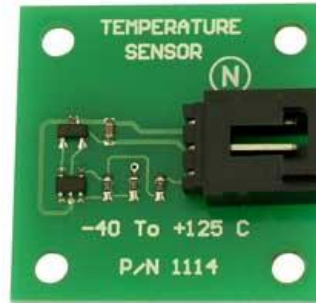

Temperature

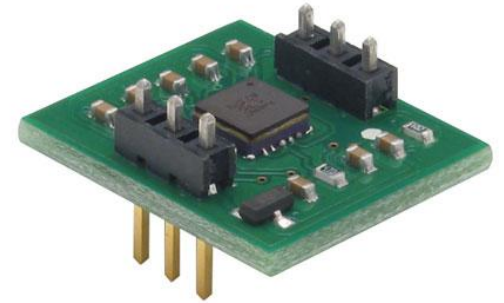

Acceleration



Humidity



Inclination

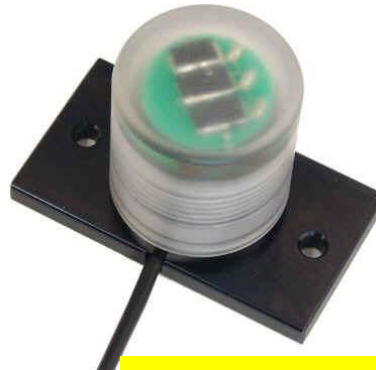

Light



EMF

# Terminology (cont)

---

- Sink

- It is similar to head node which gather, control data collected by other sensor node.

# Sink

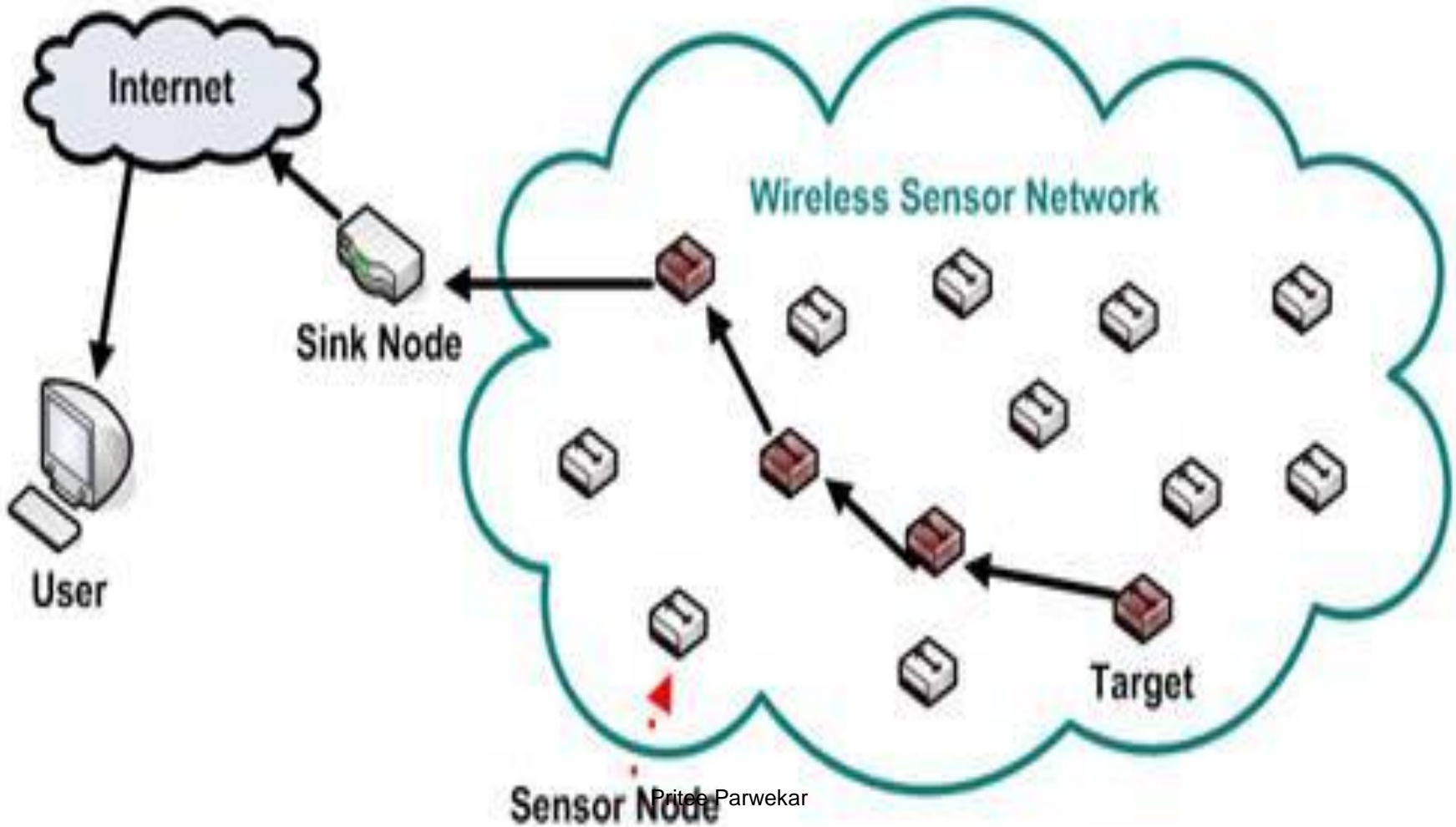

# Query scenario-Sink Node

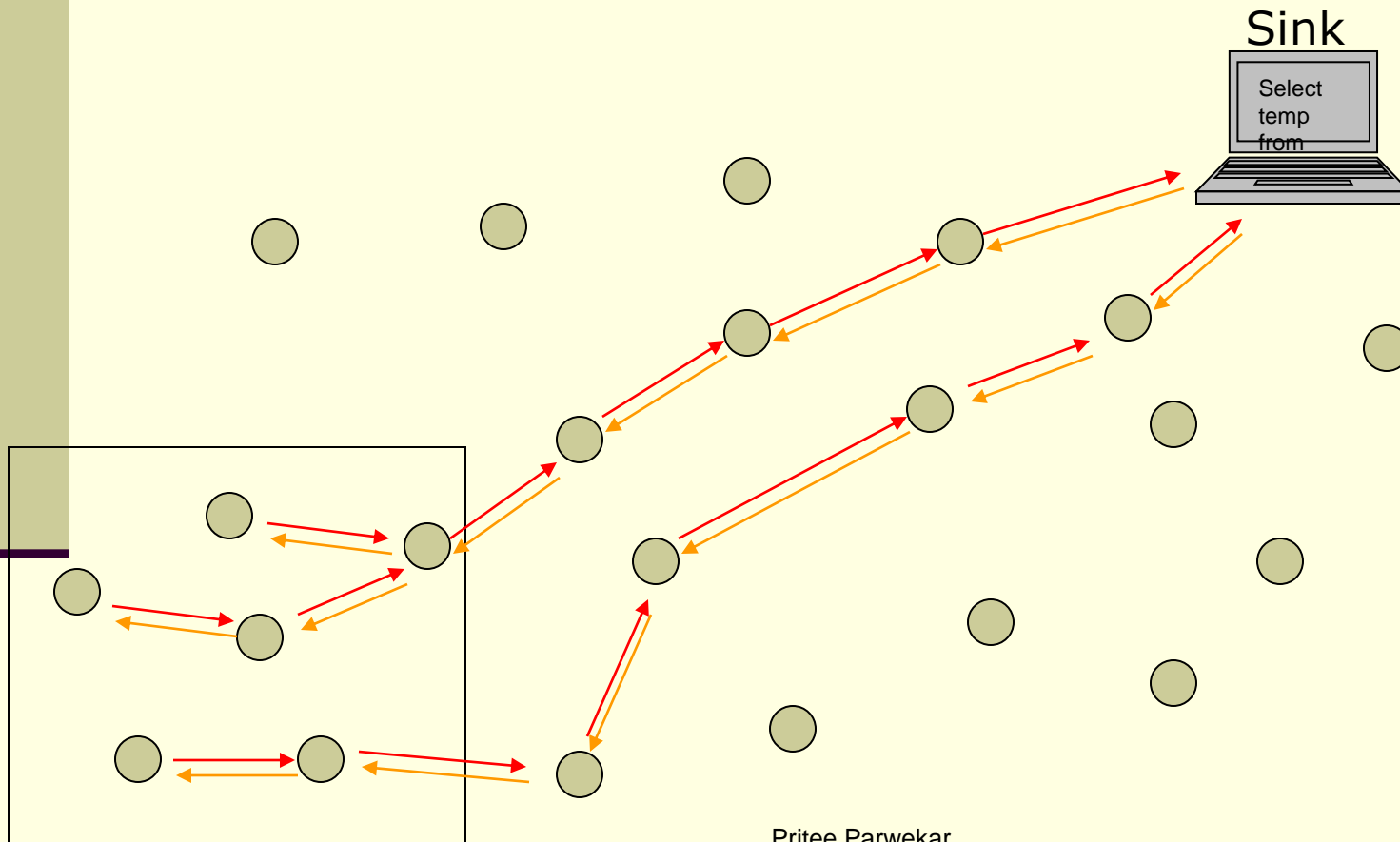



# Wireless Sensors

---

Tiny sensing devices capable of wireless communication

# WSAN

---

- A wireless sensor/actuator network (WSAN) is a group of sensors and actuators that are geographically distributed and interconnected by wireless networks. Sensors gather information about the state of physical world. Actuators react to this information by performing appropriate actions.

# Sensor

---

- Sensor is a device that measures a physical quantity and converts it into a signal which can be read by an observer or by an instrument.

# WSAN

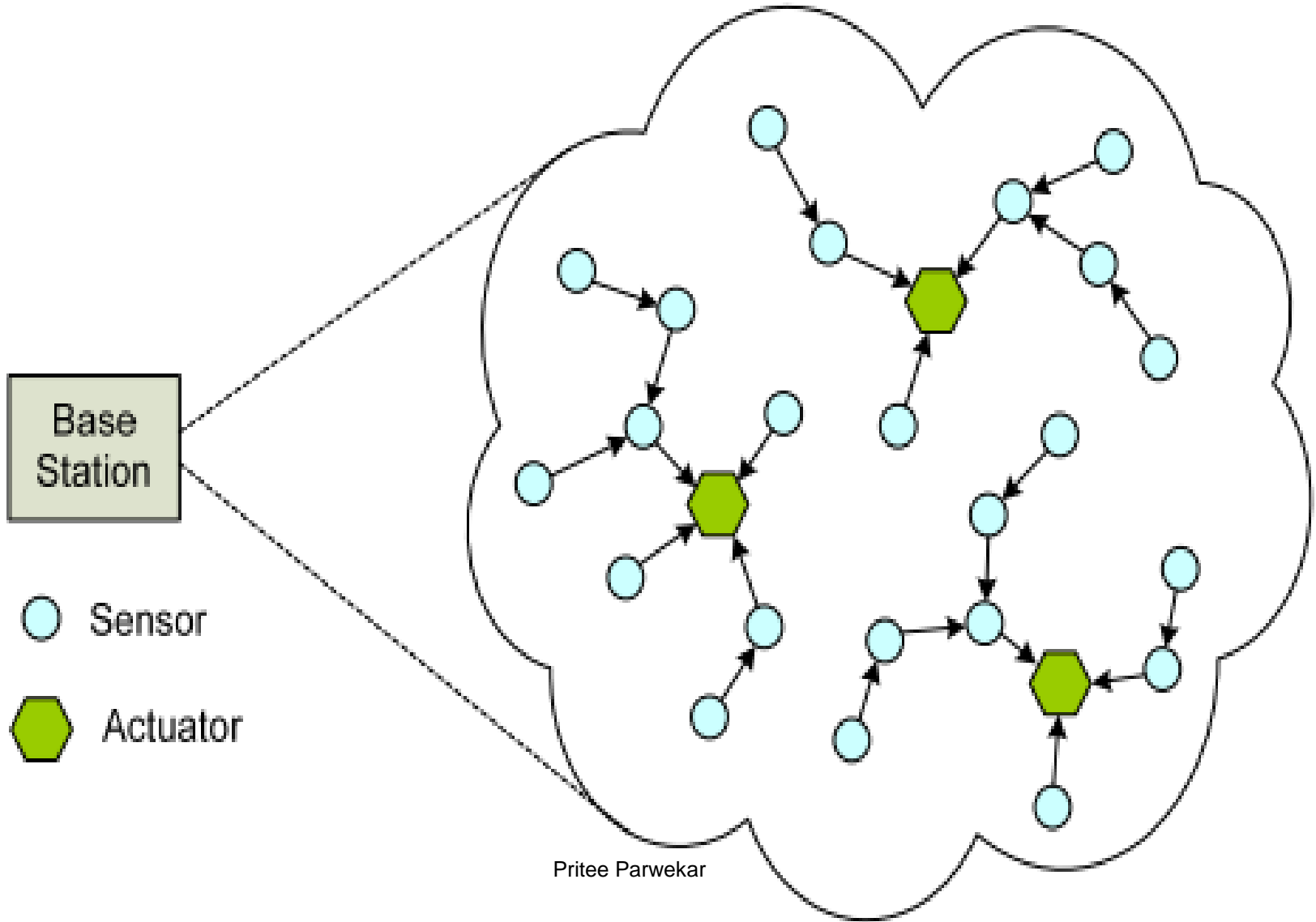

# Definition

---

- **Wireless Sensor Networks (WSNs):**
  - Highly distributed networks of small, lightweight wireless nodes,
  - Deployed in large numbers,
  - Monitors the environment or system by measuring physical parameters such as temperature, pressure, humidity.

# Node

---

- sensing + processing + communication
- WSN is built of nodes-from few to several hundreds,thousands.
- The cost of the nodes varies depending on complexities.
- Sensor nodes varies in size (from shoebox size to grain of dust).

# WSAN

---

- The development of wireless sensor network was motivated by military applications such as battlefield surveillance
- Now a days this technology is used in industrial and consumer applications.

# Components of sensor node

---

- Microcontroller
- Transceiver(with internal antenna or connection to external antenna)
- Memory
- Power Source
- Sensors



# Controller

---

- Processes the data
- Controls the functionality of other components in sensor nodes

# Transceiver

---

- The device that has both transmitter and receiver
- They are called as MAU (medium access units) in IEEE 802.3

# Antenna

---

- An antenna is a transducer that transmits or receives electromagnetic waves.
- Antenna converts electromagnetic radiation into electrical signal and vice versa.

# Power Source

---

- The sensor nodes consumes power for sensing ,communicating and data processing.
- More energy is required for data communication than any other process.
- Power is stored either in batteries or capacitors
- Batteries are both rechargeable and non rechargeable

# WSN Architecture

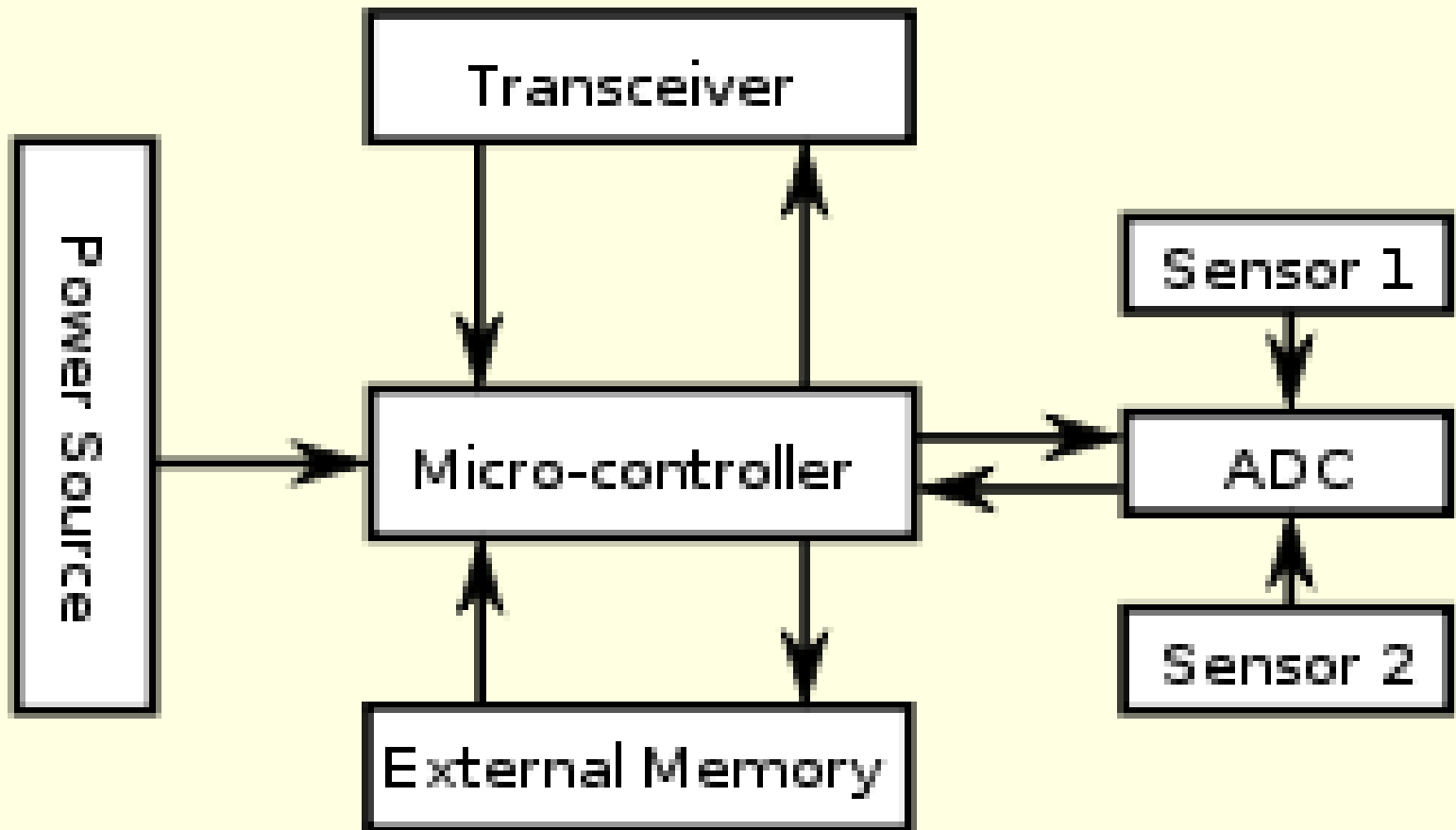

WSN General Block Diagram

Ritesh Parwekar